



Installation Recommendations

Introduction - CeDUR™ Shakes

CeDUR™ Shakes are inspired by the enduring beauty of natural cedar shakes. CeDUR™ is manufactured using state of the art polyurethane technology that was developed to withstand harsh: fire, hail, wind, and UV conditions. Discerning property owners choose CeDUR™ as the low maintenance, high performance roofing product that enhances the beauty and value of their property. The product combines the beauty of natural cedar shakes with unsurpassed durability and ease of standard shakes installation methods. CeDUR™ Shakes are a lightweight, fire, hail, and wind resistant product that are ideal for projects that demand a natural cedar shake appearance.

CeDUR™ Shakes are

- UL 2218 Class 4 impact rated
- Class “A” Fire rated without the requirement of a special fire-resistant underlayment. ASTM E108, UL 790
- Rated @ an insulation value of $R > 2.0$ R factor (approximately 20% greater than natural Heavy Cedar Shakes)
- 115 mph wind resistant rated for the “Standard Application” – at a 10” exposure. ASTM E330, UL 1897 (warrantied to 90mph)
- Above 115 mph wind resistance installations are considered “High Wind Application” – consult CeDUR™.
- Resistant to water absorption.
- Colored throughout for stability and uniformity at cuts. Solid product, no cavity back.
- Lightweight (170 lbs. per Square).
- Resistant to rot, moss, and insects
- CeDUR™ Shakes are protected by a 50 Year Limited Material Warranty.
- Ideal for new construction and re-roofing applications for residential and commercial projects.

Design

CeDUR™ Shakes are a realistic synthetic shake alternative with a nominal 3/4” thick butt edge which tapers to 1/8” thick. It is manufactured in three widths: 5¼”, 7¼”, and 12¼” & four natural wood colors. The shakes are reproductions of natural wood cedar shakes. CeDUR™ Shakes provide a personal preference option for architectural compatibility, roof appearance, fire resistance and roofing weight. Refer to the CeDUR™ Shakes Technical Specifications for details and coverage based on exposure and spacing between shakes.

Pitch

The minimum roof pitch for **CeDUR™** Shakes is a 4:12 slope. Applications below 4:12 are considered decorative. For pitches under 4:12, please consult **CeDUR™** for proper installation recommendations.

Roof Framing

CeDUR™ Shake's lightweight system allows direct replacement of existing roof systems without the structural evaluations and enhancements necessary for heavier roofing products. This product feature also holds true for new construction. No unusual design or engineering considerations are required. **CeDUR™** Shakes weigh approximately 30% less than Asphalt Architectural Shingles and less than natural Heavy Cedar Shakes. **CeDUR™** Shakes are approximately 80% less than the weight of standard Concrete Roof Tile.

Decking

Install **CeDUR™** Shakes on solid decking consisting of either code-complying, 15/32" thick American Plywood Association (APA) rated plywood, APA rated wood panels, or other building materials meeting these minimum requirements in accordance with DOC PS-1.

Temperature/Cold Climates – Storage & Installation

CeDUR™ Shakes should be stored at temperatures above 40°F and pallets should not be stacked more than two pallets high.

CeDUR™ Shakes can be installed in temperatures as low as 20°F.

Underlayment (For pitches 6:12 and above)

No special underlayment is required for a Class A Fire rating. One of the following base underlayment's is required as part of the normal application process.

- One layer of Number 30 base sheet conforming to ASTM D 226 covering the entire roof deck; or alternatively, synthetic underlayment manufactured for and utilized for shingle underlayment purposes. Verify with the manufacturer that the specific base sheet is water resistant.
- **Ice Protection**
In areas where the average daily temperature in January is 25°F (-4°C) or less, install an ice barrier that consists of a self-adhering polymer modified bitumen sheet in lieu of normal underlayment at the eaves. Extend ice protection underlayment from the eaves edge to a point at least 24 inches (610mm) inside the exterior wall line of the building.
- **Valley's**
Install a high temperature ice/water barrier that consists of a self-adhering polymer modified bitumen sheet in lieu of normal underlayment at the valley's.

To assure proper horizontal alignment we recommend that chalk lines be snapped frequently. These chalk lines should be placed on the underlayment so that the shakes are aligned by the tips rather than the butts.

*Chalk Lines should be snapped on the underlayment with the tips of the shakes following the lines. Do not snap lines on the **CeDUR™ Shakes** or use red chalk as the chalk may permanently discolor the shakes.*

Note: A base (dry in) underlayment may be installed covering the entire roof deck prior to the **CeDUR™** Shake installation assembly described above as a temporary dry-in if desired or if required by local building codes. The **CeDUR™** roofing system can be installed over existing temporary dry-in providing the material lays flat and tight to the roof deck.

Underlayment (For pitches between 4:12 and under 6:12)

In addition to one of the base sheet options described above, install one layer of ASTM D 226 type II 36-inch NO 30 underlayment at the eave line. After applying the starter shakes, a minimum 18” wide strip of interlay of ASTM D 226-type II (ASTM D 4869) No. 30 shall be laid over the top portion of the starter shakes, the butt end of the interlay course extending up-slope onto the sheathing and/or dry-in, approximately 9 inches above the fascia (For a 1 inch overhang). After installing the field shakes over the starter shakes, position the bottom edge of the next interlay on the 10-inch line of the interlay previously installed, with successive courses laid on the 10-inch line (or less depending on roof layouts less than 10”) Refer to the installation diagram following the written text.

Note: Felt interlayment on the **CeDUR™** Shakes is to be installed so it does not extend below a line that is twice the exposure above the butt (i.e. a 23.5" shakes at 10", exposure would have felt applied 20” above the butt). No felt should be visible between the side joints of the shakes (keyway). Refer to the **CeDUR™** Shakes Technical Specification Details.

Starter

CeDUR™ Shakes “Starter” is to be installed at all eave-lines. Butts of the starter shakes and first course of **CeDUR™** Shakes are to project equally beyond the finished fascia as determined by conditions to insure proper water drainage. Typical installation is a ¾” - 1 inch (25.4 mm) overhang. Where gutters are present, the overhang may be adjusted to insure proper water flow into the gutters.

Secure each 15” **CeDUR™** Starter with four corrosive resistant fasteners.

Refer to the **CeDUR™** Shakes Technical Specification Details.

Gable Ends - Rakes

Extend **CeDUR™** Shakes approximately ¾ inch over gable - rake ends.

Exposure

A 10” (254 mm) weather exposure for straight-line installations is standard, and has been used for all calculations, testing and certifications, and the basis for the product warranty. When 1” staggered installation is used, shakes exposure is laid at 9” (229 mm) exposure and random shakes are at 10” (254 mm) exposure or 1” (25.4 +/-) stagger. The maximum recommended stagger is 2 inches (8” exposure).

Spacing (Keyway) & Joint Off-Set

CeDUR™ Shakes are resistant to water absorption. Expansion and contraction due to temperature or moisture content fluctuations (hot/cold, wet/dry or freeze/thaw) is negligible, thereby permitting the choice of spacing between shakes to be based on roof appearance only.

The minimum standard keyway is 1/4" and the maximum standard keyway is 3/8".

Note: The number of **CeDUR™** shakes per square are based on a nominal 3/8" keyway.

Off-Set joints between courses a minimum of 1 1/2".

Packaging

CeDUR™ Shakes are packaged with 7 each of 5 1/4", 7 1/4", and 12 1/4" wide-pieces per bundle (total 21 pieces). The pieces are 23-1/2" length. When installed with a Standard 10" weather exposure and a 3/8" keyway, 168 field pieces or 8 bundles will cover 1 roofing square (SQ). Closer spacing between shakes will require additional field pieces.

Color

CeDUR™ Shakes will, by design, shift color upon exposure to the sun. This color change takes place gradually over a four to eight-week period (depending on time and intensity of sun exposure) and then stabilizes at a weathered wood color for the life of the product.

Installation

CeDUR™ Shakes are applied on solid sheathing / wood board and plank roof decks in the same manner as wood shakes, in accordance with National Roofing Contractors Association (NRCA) guidelines and applicable building codes. Refer to the detail schematics following the written text.

Workability

CeDUR™ Shakes may be sawn, planed, sanded, nailed, stapled, and/or screwed with common roofing tools and materials. It will not split to width in the traditional wood shakes installation manner due to its non-fibrous and uniform composition. The shakes can also be scored with a utility knife and snapped at the score-line.

CeDUR™ Shakes requires no sealing or treatment to cut edges due to their closed cell structure which permits no significant water absorption.

Fastening – Standard Application

Secure each 5 1/4" and 7 1/4" **CeDUR™** Shake with two (2) corrosive resistant fasteners; and, each 12 1/4" **CeDUR™** Shake with three (3) corrosive resistant fasteners.

Nails: minimum 11-gauge shank and 5/16" head, ring shank roofing nails (1 3/4" in length typically). This is the recommended fastener.

Staples: 15/16" CRN by 16 GA by (1-7/8" in length typically). Building code dependent.

Screws: Corrosive resistant screws with a minimum 5/16" head may also be used.

Fasten a minimum 1" from shakes edge and place in the fastening zone 1" above the butt line of the course to follow. Fasteners shall be of sufficient length to fully penetrate a minimum of 3/4" into and / or through the decking. Do not fasten through the void area between shakes and roof deck unsupported by the **CeDUR™** Shakes course below. Fasteners are to be driven flush to the product surface; and, not over driven or under driven. Fasteners are to be driven perpendicular to material face. Fastener placement marks are located on **CeDUR™** Shakes with a dimple mark.

Non-compliance to these fastening requirements may void the warranty.

Hip and Ridge – Factory Formed & Two-Piece Field Assembled

Pre-formed one-piece units (10” (254 mm) exposure). Two (2) concealed roofing fasteners per side, four (4) total fasteners per piece (see fastener section – increase length) are required at the over-lap. Install 1 layer of #30 felt under the hip & ridge pieces.

Pitch Range for Hip & Ridge - Factory Formed

4:12 – 7:12 Low Hip : Low Ridge.

Above 7:12 – 11:12 Low Hip : Medium Ridge.

Above 11:12 – 14:12 Medium Hip : High Ridge.

Above 14:12 – 21:12, Ridge to be field assembled per below instructions

Two Piece – Field Assembled

CeDUR™ Shakes supplied for this Hip & Ridge option are 5 1/4" wide field pieces. The Weather Exposure is the same as the field exposure of the roof shakes. Pieces are to be alternately lapped. Standard roofing gauge fasteners of sufficient length to fully penetrate roof sheathing / boards is required, placed two per side, driven a minimum of 1” from each edge, and 1” - 2” above the butt line of the course to follow. Fasteners are to be concealed by the subsequent overlapping unit. Install 1 layer of #30 felt under the ridge pieces. Refer to the **CeDUR™** Shakes Technical Specification Details.

12-inch-wide – Piece Bundle (optional)

Bundles of 12” **CeDUR™** Shakes are available as an accessory option to provide additional pieces for valley/hip cuts. This accessory option helps to minimize waste and facilitate job site production.

Snow Brackets (Optional)

Standard snow brackets should be considered in areas with high snow load requirements.

Metal Flashing

Roof flashing shall not be less than No. 26 gauge (0.019 inches - .048 mm) corrosion resistant sheet metal.

Sections of flashing shall have an end lap of not less than 4 inches (102 mm).

Single crown (W) valley flashing shall extend 11 inches (279 mm) from the centerline each way. A 36” minimum width, high-temperature self-adhered polymer modified bitumen membrane underlayment shall be installed in the valley prior to valley metal installation.

Reference Detail # 2 on page # 8 for the two acceptable methods of valley metal installation:

Stripped in edge flanges or Hemmed edges secured with metal clips and fasteners which do not penetrate the valley flashing.

Chimney / Skylight / Side Wall - Step Flashing

Step flashing is to extend not less than 5” under the shakes and not less than 5” up the vertical surface that the shakes butt up against. A moisture-resistant barrier is to be installed between galvanized flashing and vertical surfaces. When chimneys, curbs, skylights, or any vertical protrusion through the roof are at least 30” wide; saddles or crickets are required. These flashings are to extend not less than 10” under the shakes. In areas with adverse weather conditions, extended metal flashing lengths and / or a 36” wide layer of pressure sensitive polymer modified bitumen flashing strip-in sheet are required.

Step flashing must be used where vertical surfaces occur in connection with slopes. Flashing is to be formed of separate pieces, installed with each course of shakes, and lap no less than 3". Counter-flashing is to be installed in a step manner to follow the joints of masonry and be ragged into mortar joints / properly surface mounted.

Dormer Flashing

Dormer flashing shall run up not less than 6" under the shakes and a minimum of 5" up the vertical interface. Windows, caps, and all other projections at points where rainwater accumulates are to be protected with metal flashing. Metal flashing is to be extended up under the shakes at the sidewalls and behind outside finish materials for a distance of at least 5". In areas with adverse weather conditions, extended metal flashing height is recommended.

Pipe Flashing

All pipes projecting through roofs must have a deck flashing and be water proofed appropriately. The flashing flanges are to extend out on the roof not less than 6". The flashing flanges are to be of sufficient length to cover the shakes course below the pipe, and extend up under the butt of the course above, as far as possible without being punctured by fasteners. Maintain a 1" (25.4 mm) shakes clearance around the pipe projection.

Safety and Health

Occupational Safety and Hazard Administration (OSHA) prescribed safety standards, are to be followed during product loading and installation; as well as and any subsequent roof traffic.

Product Dimensions

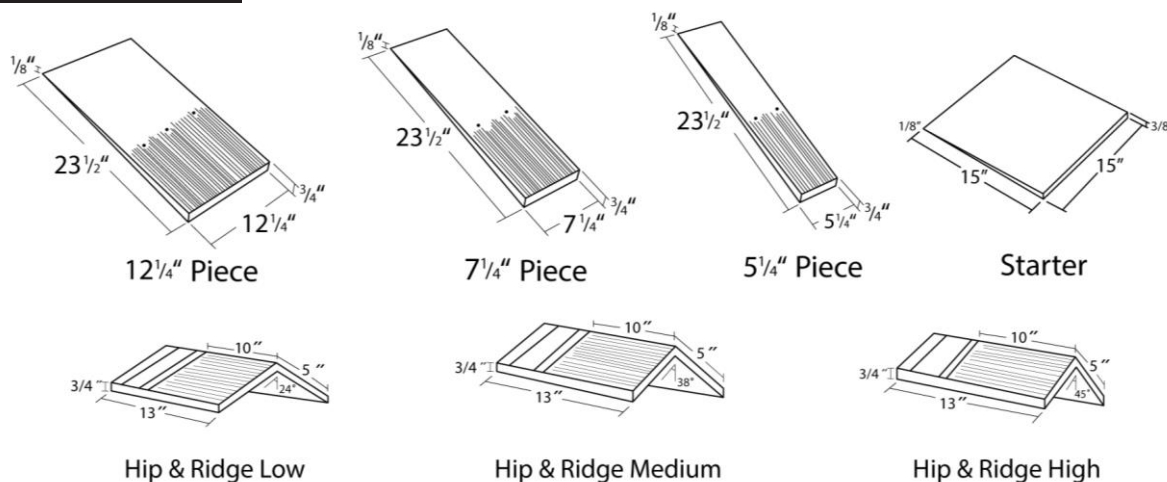

Available Sizes & Installed Weight

Length	23 1/2"
Width	5 1/4", 7 1/4", 12 1/4"
Thickness	3/4" tapered to 1/8"
Installed Weight per 100 sq. ft.	170 lbs.
Pieces per Bundle	7 pieces each of 5 1/4", 7 1/4", & 12 1/4" shakes
Bundles per pallet	36

Coverage (based on 3/8" standard keyway)	
10" Standard Exposure	
SQ/Bundle	0.125
Pieces/SQ	168
SQ/8-Bundles	1
SQ/Pallet of 36 Bundle	4.5

CeDUR Diagrams – CeDUR installs in a similar fashion to cedar shakes

Use CeDUR material where wood shakes are referenced in the following drawings, drawings are used with permission from NRCA. **The recommended fastener is ring shank roofing nails, hot dipped galvanized 1 ¾" inch in length, 11 gauge 5/16" head.** Fastener placement marks are located on CeDUR shakes with a dimple mark. Two (2) fasteners per 5 ¼" and 7 ¼" CeDUR shake, and three (3) fasteners per 12 ¼" CeDUR shake. Do not snap chalk lines on the CeDUR shakes or use red chalk as the red chalk may permanently discolor the shakes.

1.) Standard Field Lay-out Drawing

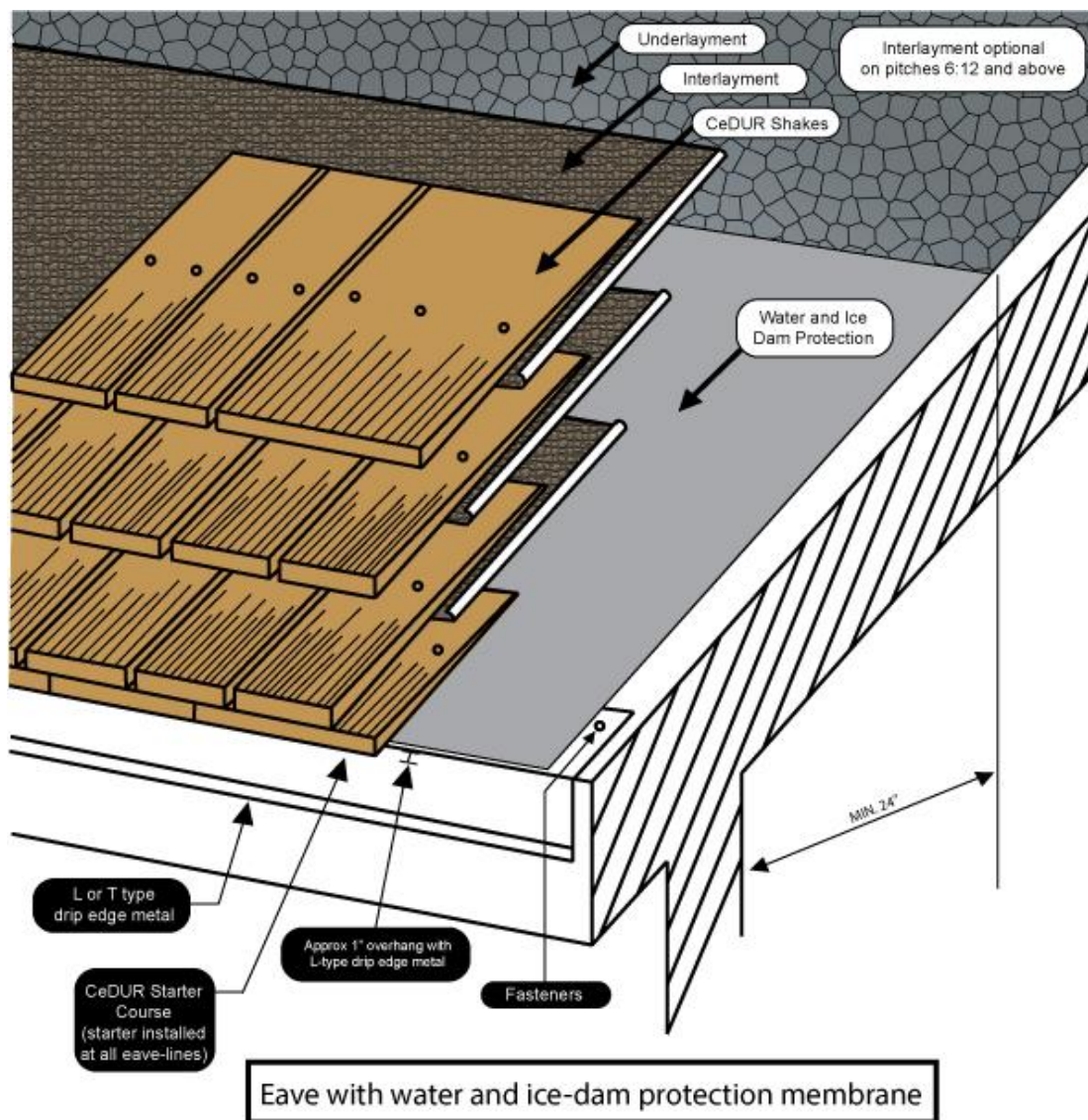

Eave with water and ice-dam protection membrane

* For 6:12 pitch and above the interlayment is not required

2.) Valley Flashing Detail (use either of the two options detailed below)

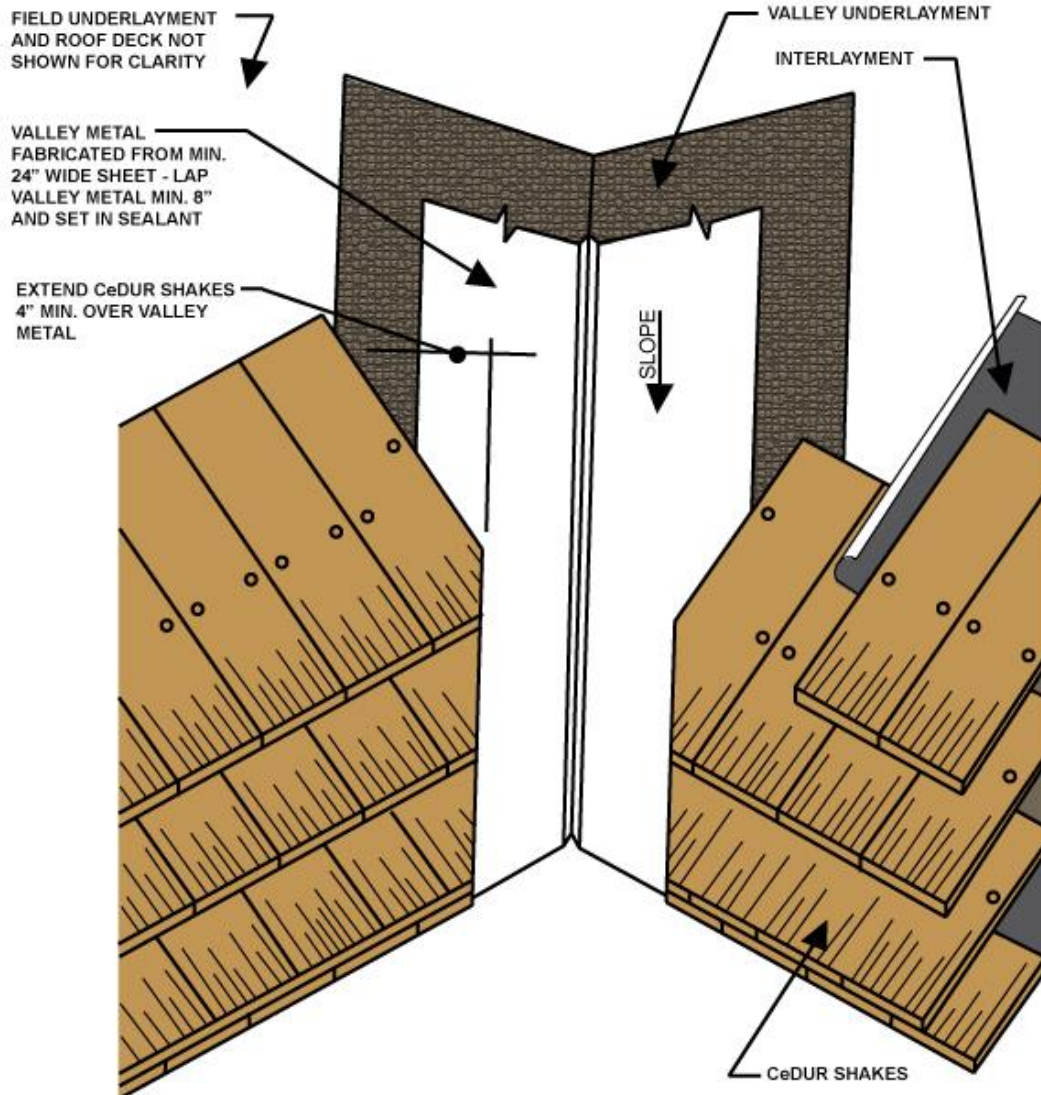
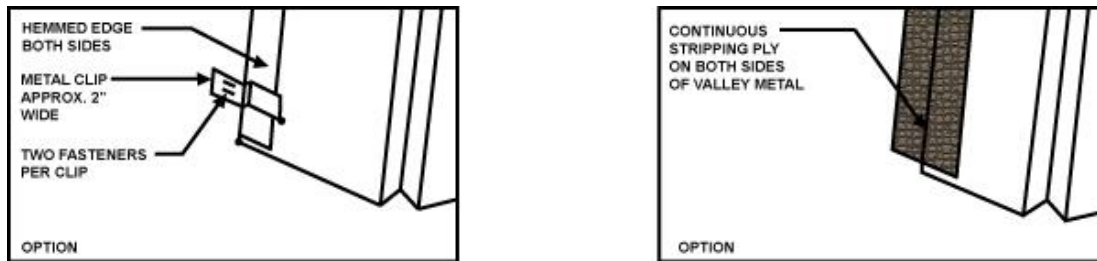

NOTES:

1. VALLEY UNDERLAYMENT TYPE AND NECESSITY MAY VARY DEPENDING ON CLIMATIC CONDITIONS.
2. SHAKES SHOULD NOT BE FASTENED THROUGH METAL VALLEY.

OPEN VALLEY

3.) Cricket Flashing

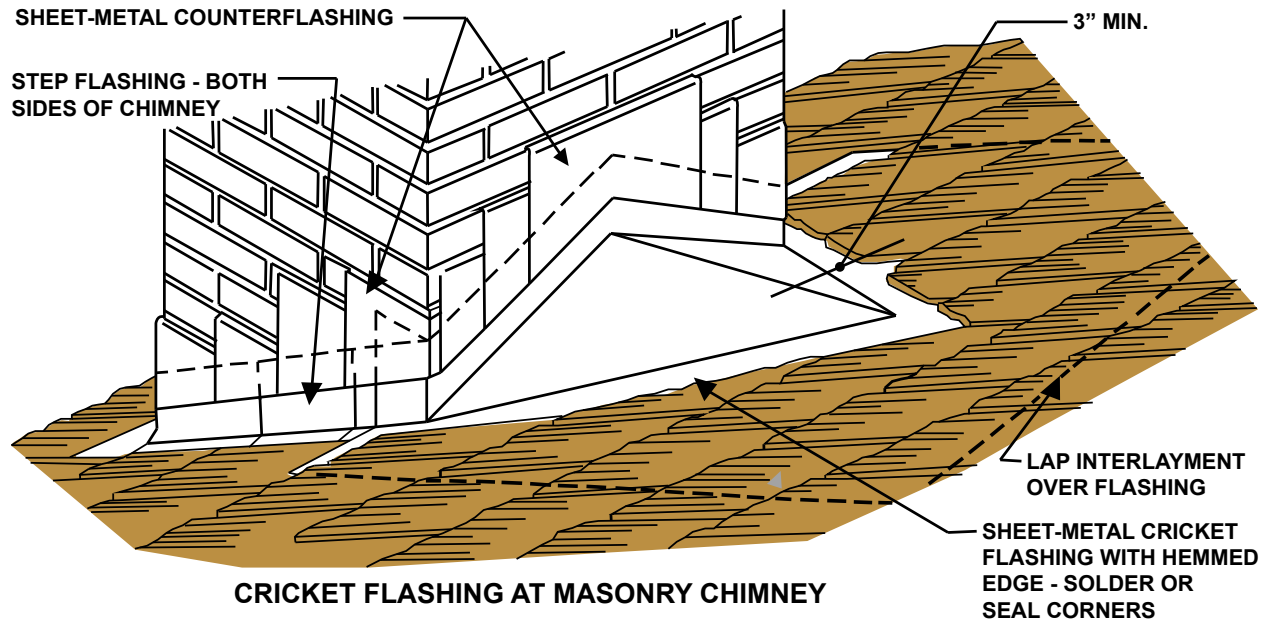

4.) Apron Flashing

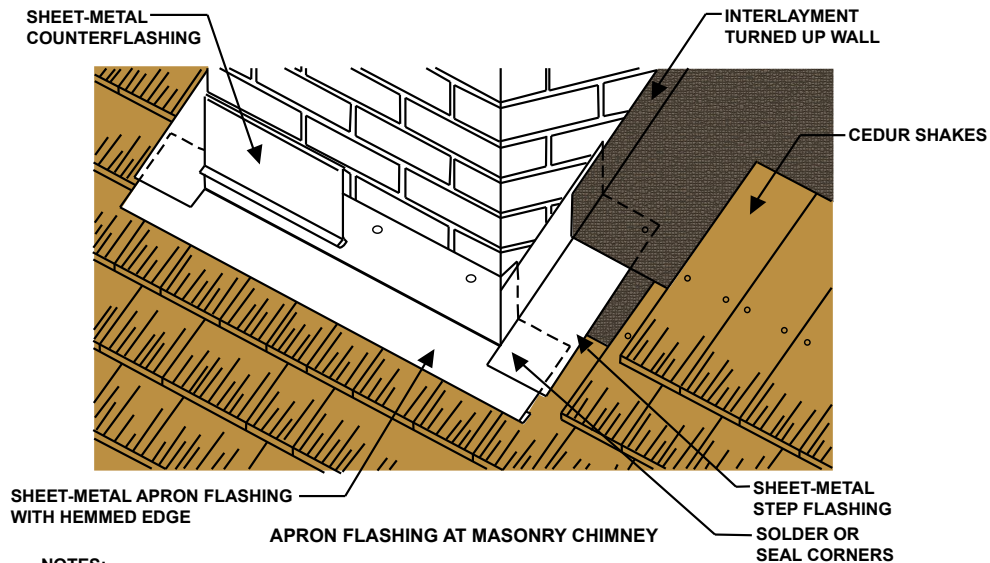

CHIMNEY WITH CRICKET FLASHING

5.) Vent Pipe Flashing

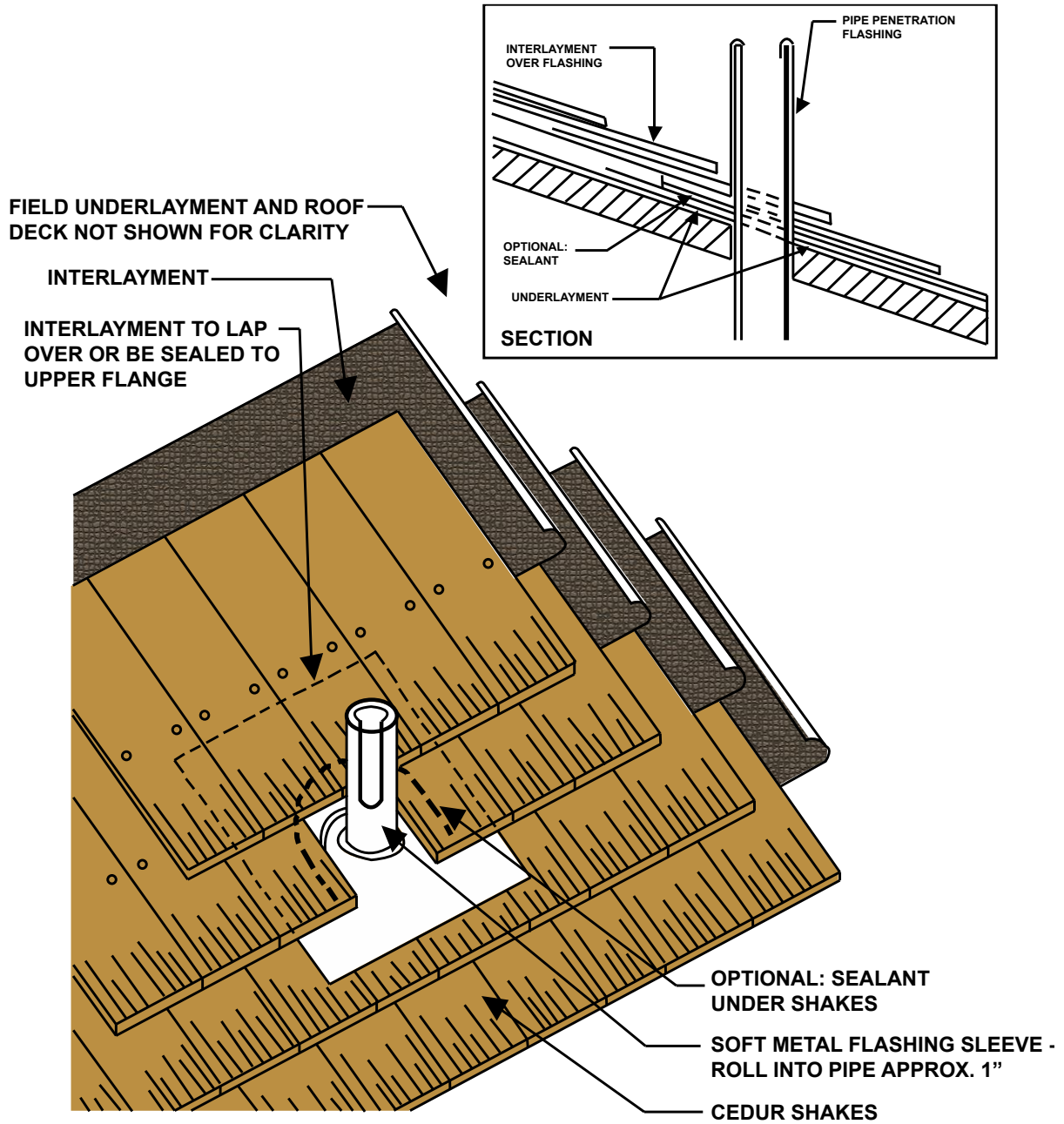

VENT PIPE PENETRATION

6.) Sidewall Step Flashing

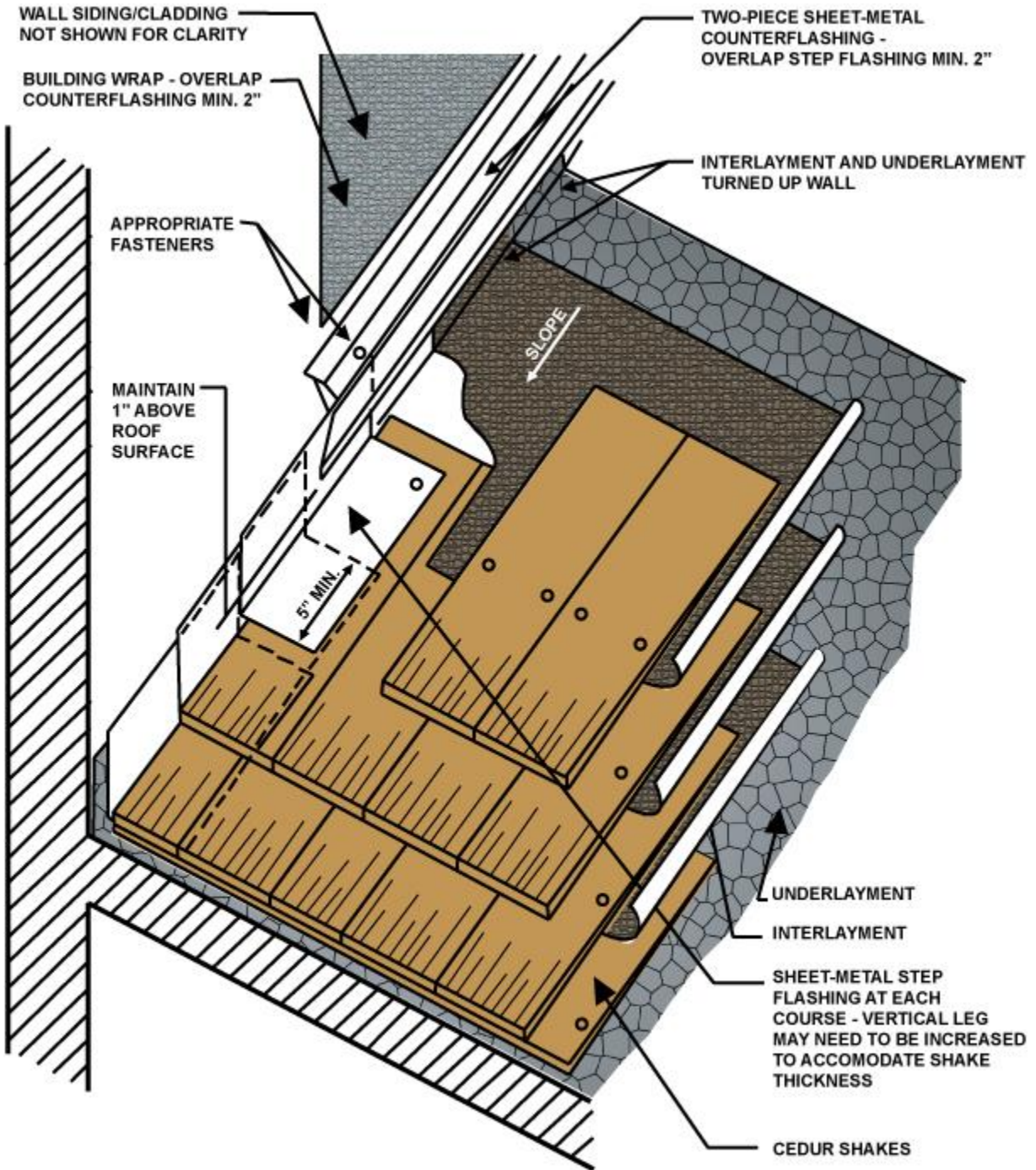

SIDEWALL FLASHING WITH TWO-PIECE COUNTERFLASHING

7.) Curb Mounted Skylight Flashing

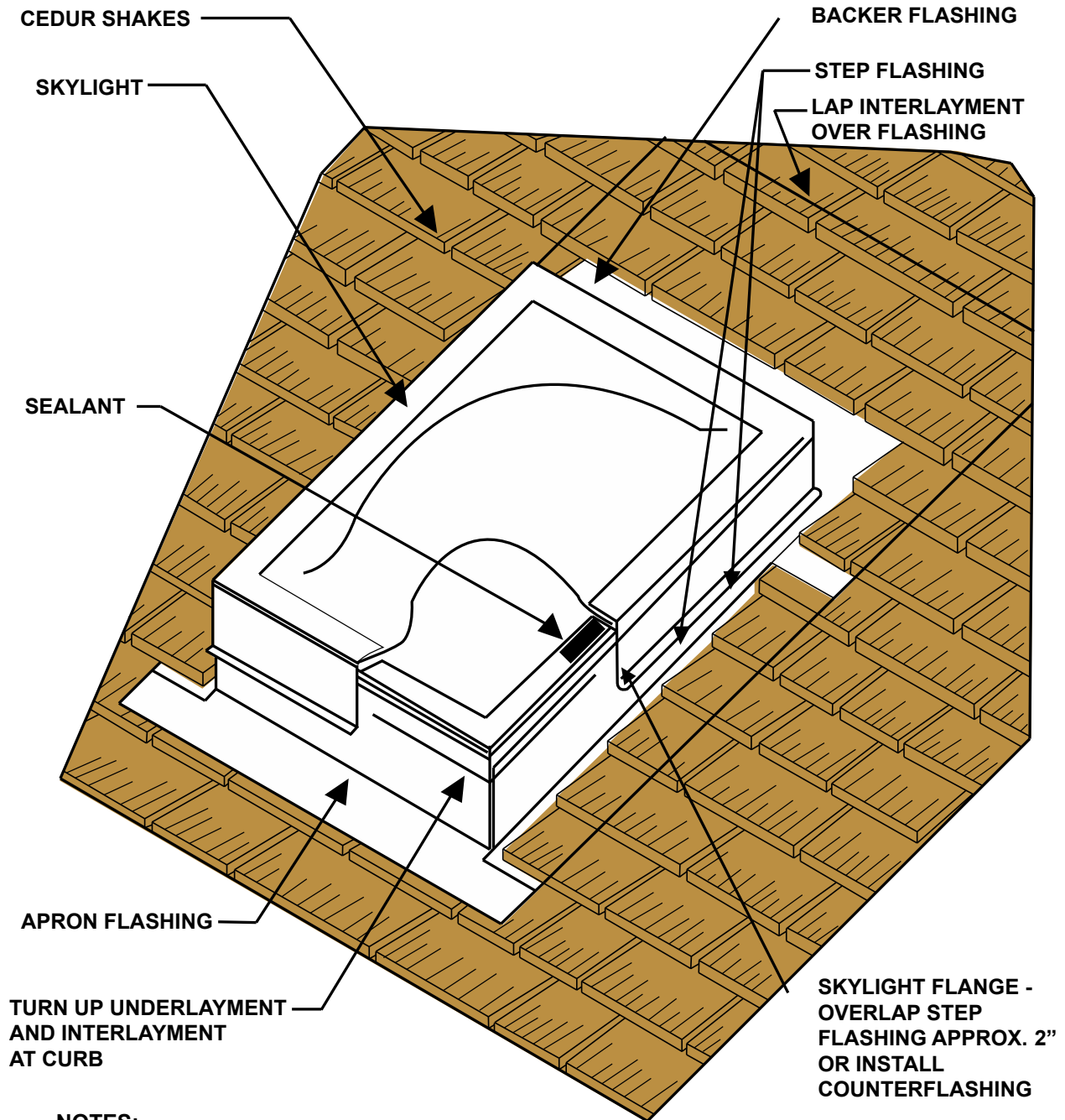

NOTES:

1. WHERE DEEMED NECESSARY, HOLD CEDUR SHAKES UP ONE COURSE DEPENDING ON ANTICIPATED DEBRIS, AND/OR SNOW ACCUMULATION.
2. INSTALL CRICKET AT SKYLIGHTS THAT ARE WIDER THAN 24 INCHES.
3. REFER TO THE INTRODUCTION OF THE CONSTRUCTION DETAILS CHAPTER FOR ADDITIONAL INFORMATION.

CURB-MOUNTED SKYLIGHT

8.) Headwall Flashing

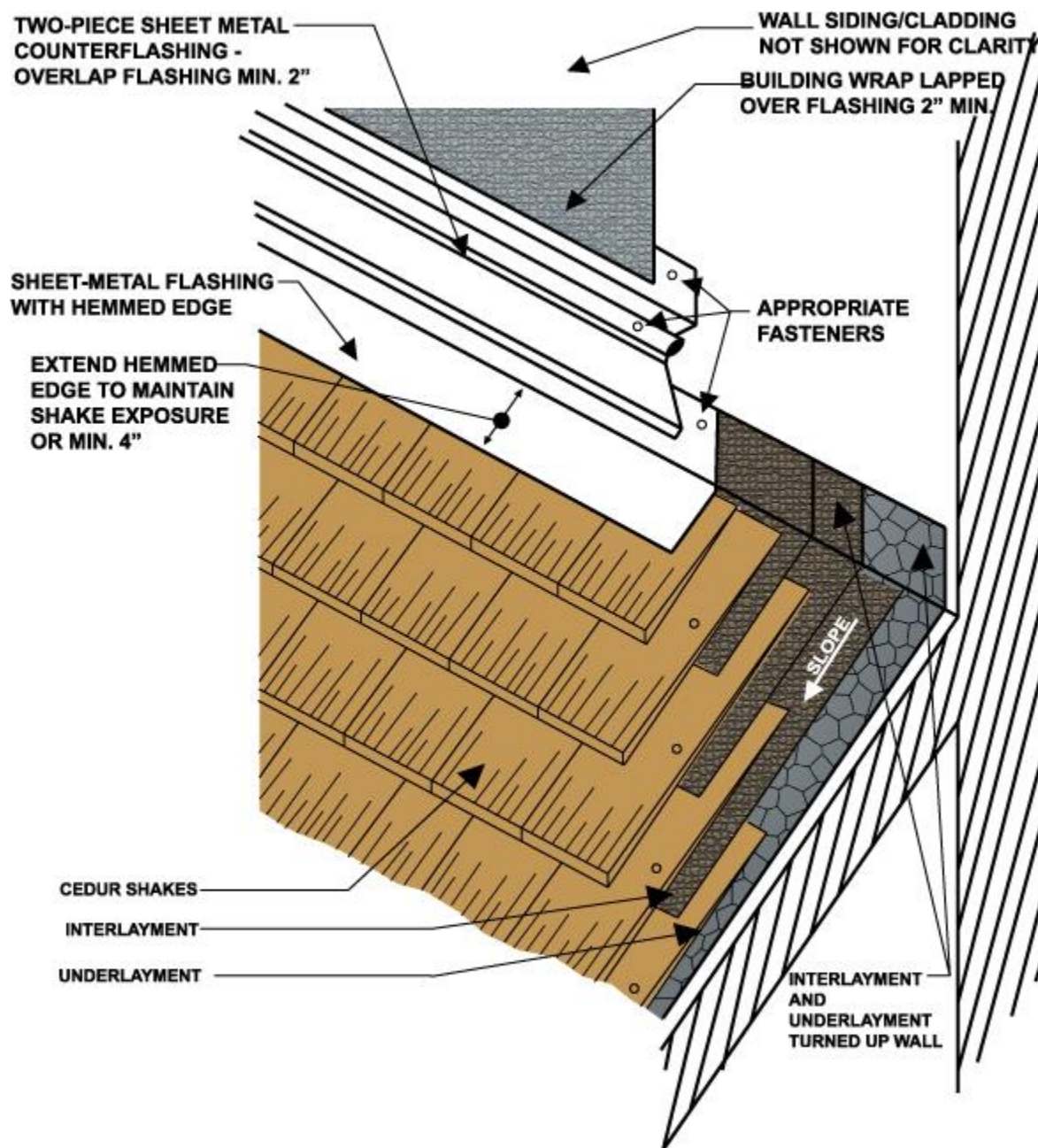

HEADWALL FLASHING

9.) Mansard Roof Details

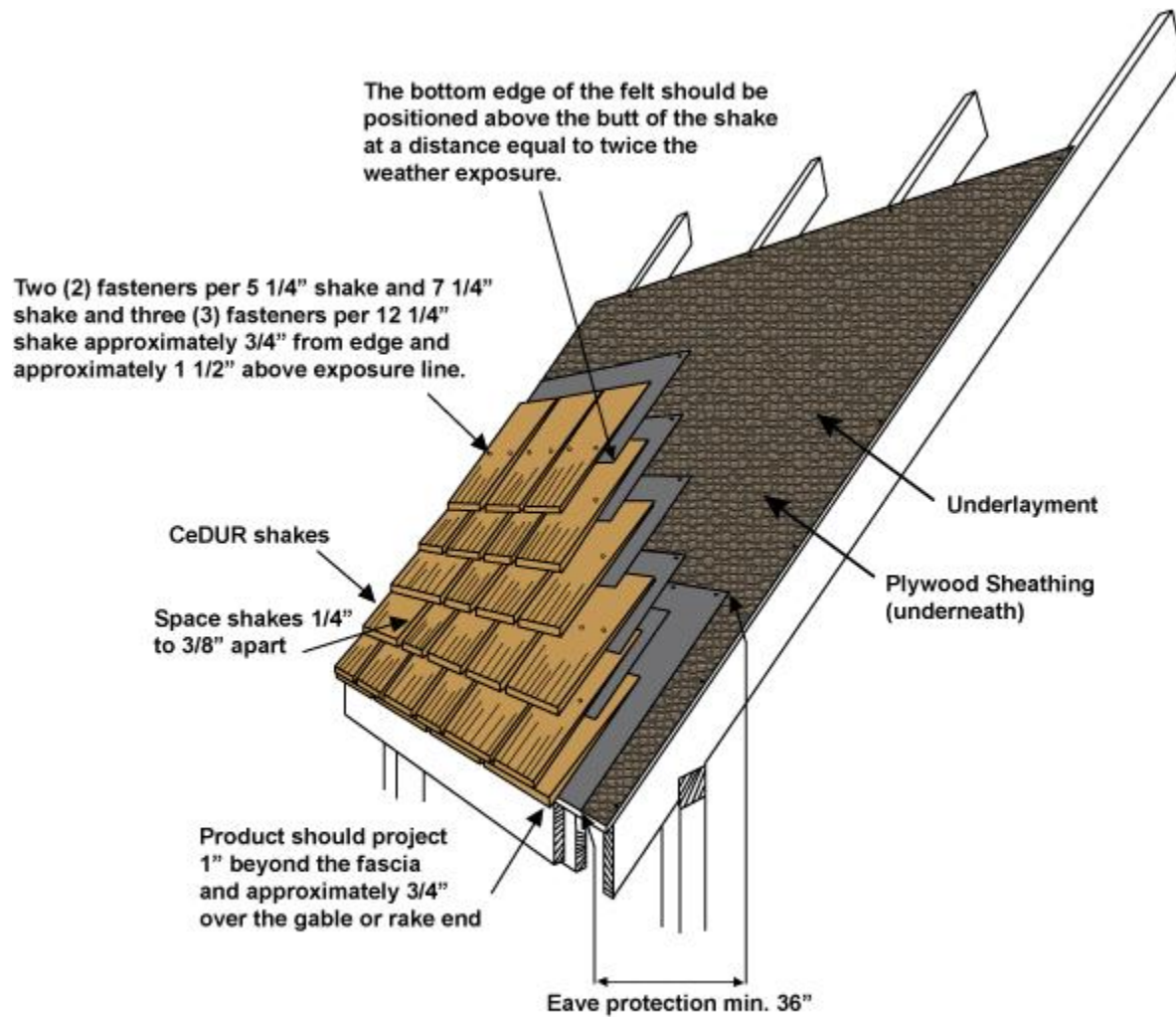

MANSARD ROOF DETAILS

10.) Shake Application

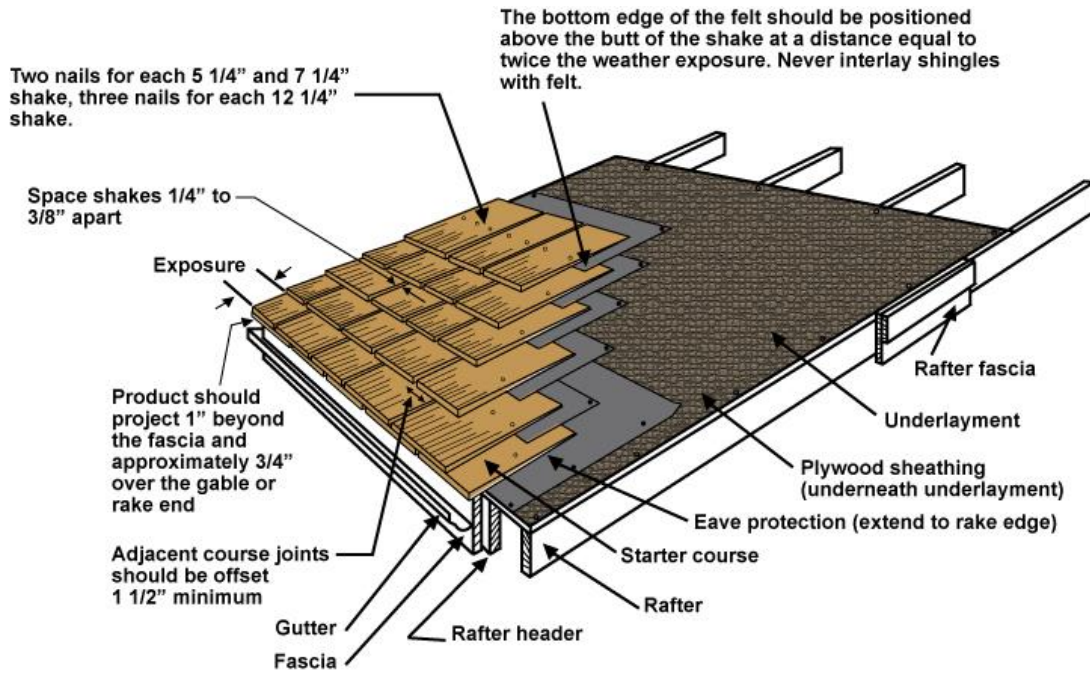

SHAKE APPLICATION

11.) Saddle Flashing Detail

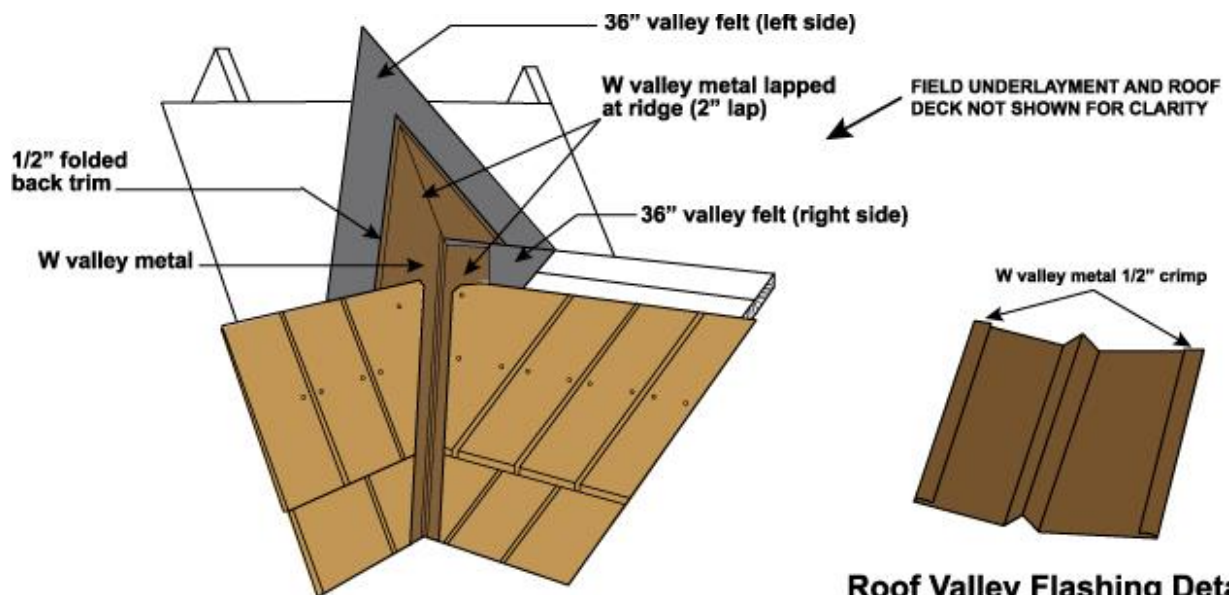

Saddle Flashing Detail

Roof Valley Flashing Detail

12.) Ridge Detail

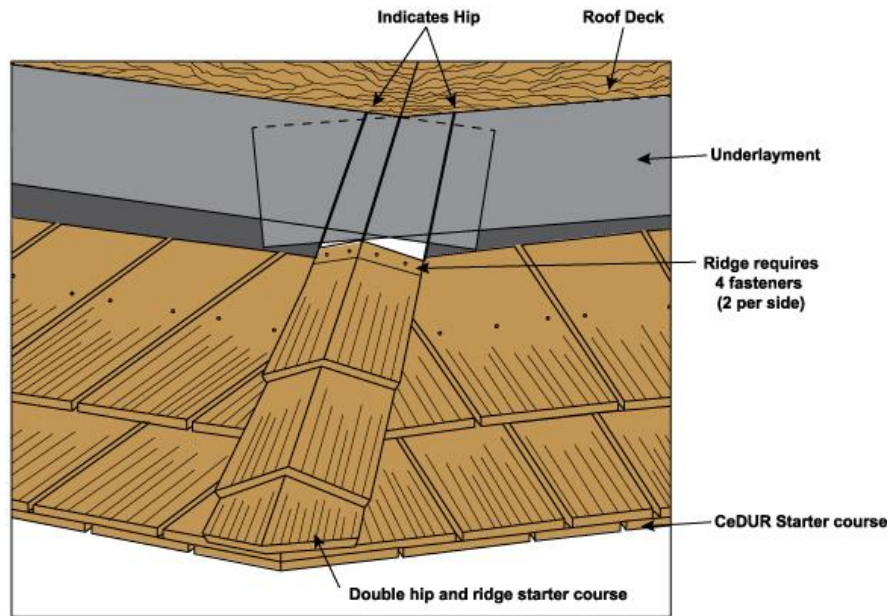

13.) Convex Roof Juncture

CONVEX ROOF JUNCTURE

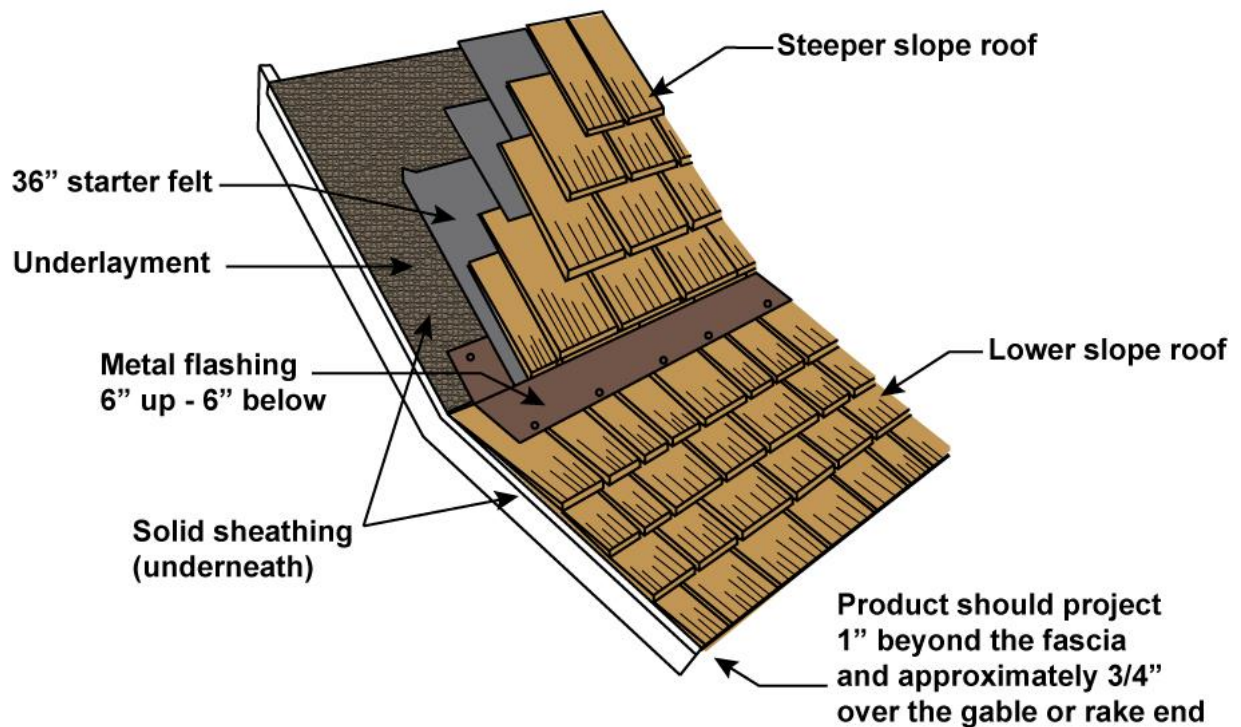

14.) Fastener Guideline

ROOF FASTENER GUIDELINE

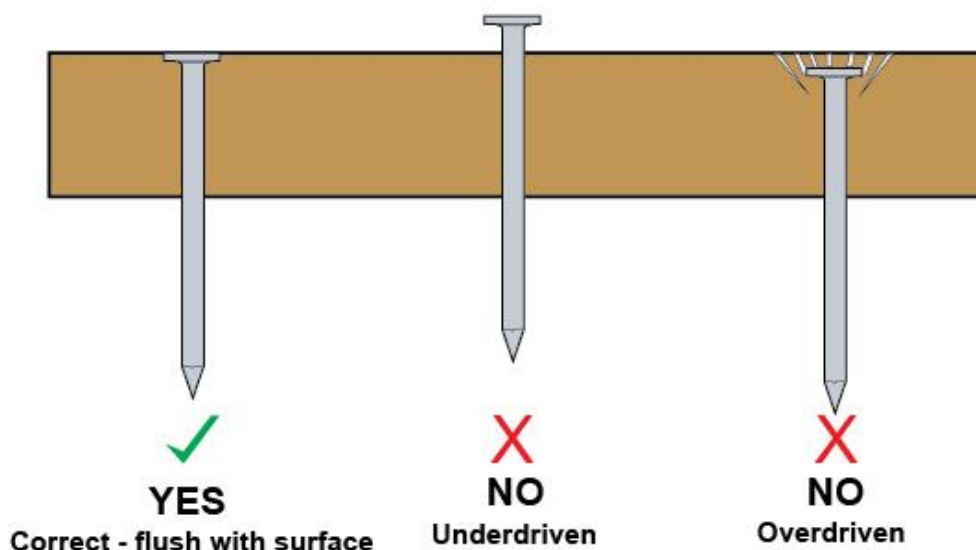

LOCATION / PENETRATION

Fasteners: two (2) corrosive resistant fasteners per shake for 5 1/4" and 7 1/4" pieces and three (3) corrosive resistant fasteners per shake for 12 1/4" pieces. Fasteners shall be long enough to penetrate into the sheathing at least 3/4" or all the way through. Fasteners must be driven flush with the surface of the CeDUR shake. Misplacing or overdriving the fastener can split and/or distort the CeDUR shake.

- **Nails:** minimum 11-gauge shank and 5/16" head, ring shank roofing nails (1 3/4" in length typically) - recommended fastener
- **Staples:** 15/16" CRN by 16 GA by (1-7/8" in length typically). Building code dependent.
- **Screws:** Corrosive resistant screws with a minimum 5/16" head may also be used.

Fasten a minimum 1" from shakes edge and place in the fastening zone 1" above the butt line of the course to follow. Fasteners shall be of sufficient length to fully penetrate a minimum of 3/4" into and/or through the decking. Do not fasten through the void area between shakes and roof deck unsupported by the CeDUR shakes course below. Fasteners are to be driven flush to the product surface; and, not over driven or under driven. Fasteners are to be driven perpendicular to material face. Fasteners are to be concealed by the subsequent overlapping shake. Non-compliance to these fastening requirements may void the warranty.

15.) Course Alignment

COURSE ALIGNMENT

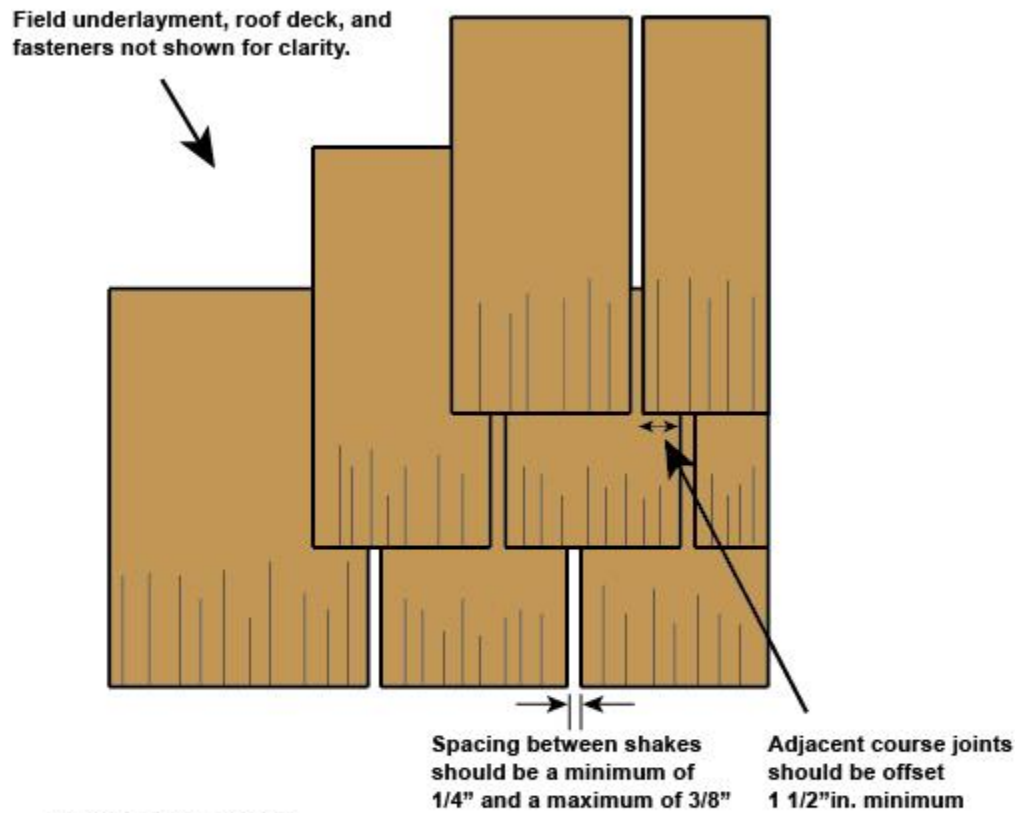

APPLICATION

1. Spacing between adjacent shakes (joints) should be a minimum of 1/4" and a maximum of 3/8" in.
2. Adjacent course joints should be offset 1 1/2" in. minimum.

CeDUR Synthetic Roofing Products

Installation Tips

- Only experienced professionals who follow proper safety and workmanship practices should implement the information contained herein.
- The contents of this manual are not intended to supersede local jurisdiction requirements or building code. Check with local building code official for local jurisdiction requirements.
- Different climates have different code requirements. Ensure the right products and installation methods are used per the building code official in your area.
- CeDUR shakes will, by design, shift color upon exposure to the sun. This color change takes place gradually and then stabilizes at a weathered wood color for the life of the product.
- Occupational Safety and Hazard Administration (OSHA) prescribed safety standards are to be followed during product loading and installation, as well as and any subsequent roof traffic.
- Ring shank roofing nails hot dipped galvanized 1 3/4" in. in length, 11-gauge 5/16" head are the recommended fastener.
- Do not snap chalk lines on the CeDUR shakes or use red chalk as the red chalk may permanently discolor the shakes.
- A 10" (254 mm) weather exposure for straight line installations is standard, and has been used for all calculations, testing and certifications, and the basis for the product warranty. When 1" staggered installation is used, shakes exposure is laid at 9" (229 mm) exposure and random shakes are at 10" (254 mm) exposure or 1" (25.4 +/-) stagger. The maximum recommended stagger is 2 inches (8" exposure).
- CeDUR Starter Shakes are to be installed at all eave-lines. Butts of the starter shakes and first course of CeDUR shakes are to project equally beyond the finished fascia as determined by conditions to insure proper water drainage. Typical installation is a 3/4" - 1" inch (25.4 mm) overhang. Where gutters are present, the overhang may be adjusted to insure proper water flow into the gutters.
- When installed with a standard 10" weather exposure and a 3/8" keyway, 168 field pieces or 8 bundles will cover 1 roofing square (SQ).
- To assure proper horizontal alignment we recommend that chalk lines be snapped frequently. Chalk lines should be snapped on the underlayment with the tips of the shakes following the lines.
- These chalk lines should be placed on the underlayment so that the shakes are aligned by the tips rather than the butts.
- When tabbing down or making repairs the recommended silicone is GE Clear Silicone II silicone adhesive/caulk, or Rainbuster 12000 Clear silicone adhesive.
- Windows, caps, and all other projections at points where rainwater accumulates are to be protected with metal flashing. Metal flashing is to be extended up under the shakes at the sidewalls and behind outside finish materials for a distance of at least 5".
- Fasteners shall be of sufficient length to fully penetrate a minimum of 3/4" into and/or through the decking.
- Fastener placement marks are located on CeDUR shakes with a dimple mark.
- Two (2) fasteners per 5 1/4" CeDUR shake and 7 1/4" CeDUR shake, and three (3) fasteners per 12 1/4" CeDUR shake.
- Do not drive nail heads or staple crowns below the CeDUR product. Overdriving or underdriving the fasteners can seriously damage the integrity of the roofing system.
- Fasteners are to be concealed by the subsequent overlapping shake.
- Fasten a minimum 1" from shakes edge and place in the fastening zone 1" above the butt line of the course to follow.

- Non-compliance to these fastening requirements may void the warranty.
- Never interlay shingles with felt.
- No special underlayment is required for a Class A Fire Rating.
- Underlayment must be a minimum of one layer of Type II (No. 30) asphalt-saturated felt complying with ASTM D226.
- Interlayment, when required, must be one layer of minimum 18-inch-wide (457 mm) Type II (No. 30) asphalt-saturated felt complying with ASTM D226.
- No felt should be visible between the side joints of the shakes (keyway).
- The minimum standard keyway is 1/4" and the maximum standard keyway is 3/8".
- Keyways must not be aligned and must be a minimum 1 1/2" in. offset from the course above. Offset joints between courses a minimum of 1 1/2".
- CeDUR shakes must be installed on solid sheathing consisting of minimum 15/32 inch (11.9 mm) exterior-grade plywood sheathing 7/16 inch thick (11.1 mm) oriented strand board (OSB) or nominally 1-inch-thick (25.4 mm) lumber complying with the applicable code.
- Flashing must be a minimum No. 26 gage [0.019 inch (0.483 mm)] corrosive-resistant sheet metal.
- Minimum and maximum shake exposure: 8 inches (203 mm) and 10 inches (254 mm).
- Maximum exposure for shake rows is 10", measured butt to butt.
- 18" shake liner (interlace) between shake rows for slopes 4:12 – 6:12.
- Slopes steeper than 6:12 do not require shake liner.
- Ice and water shield where required by code.
- Staggered butt applications are made by shortening the exposure less than the greater maximum exposure. No shakes shall be applied greater than the maximum exposure allowed. Check with local building codes for approval of this installation method.
- CeDUR shakes require no sealing or treatment to due edges due to their closed cell structure which permits no significant water absorption.
- CeDUR shakes should be stored at temperatures above 40 degrees Fahrenheit and pallets should not be stacked more than two pallets high. CeDUR shakes can be installed in temperatures as low as 20 degrees Fahrenheit.

To obtain product warranty, the Completion of Work Form is to be submitted to info@cedur.com within 90 days of job completion.

TAB DOWN PROCEDURE FOR INCREASED WIND RESISTANCE

Using Stainless Steel Screw

MATERIAL:

- **GE CLEAR Silicone II silicone adhesive/caulk (Quarter- Half Dollar size application)**
OR
- **Rainbuster 12000 Clear Silicone (Quarter- Half Dollar size application)**

Tabbing down a CeDUR roof or individual shakes for increased wind resistance.

Purpose: The following procedure can be used with CeDUR Shakes to greatly improve wind resistance of your CeDUR roof. Although reduced coursing alone increases CeDUR wind resistance significantly, in extremely wind and gusty areas, tabbing the roof, or sections of the roof, will improve wind resistance. This procedure and material can also be used to reinstall a broken shake that has come off your roof for whatever reason.

Step 1.

CeDUR recommends GE Silicone II silicone adhesive/caulk OR Rainbuster 12000 Clear Silicone adhesive for this application method. (See pictures below) GE silicone II or Rainbuster 12000 Clear Silicone (as well as their other caulks and adhesives) are marketed in several different packages such as for sinks, baths, countertops, garages, basements, exterior windows, etc. Don't worry about which one you use, just make sure it is GE Silicone II (Clear) OR Rainbuster 12000 Clear Silicone.

Step 2.

The CeDUR shake will have to be lifted slightly in order to apply the adhesive. See picture below. The colder the weather the more rigid the product will be so lifting the shake only enough to be able to insert the dispensing tip of the tube under the Shake.

A quarter or half dollar size dollop of material is recommended. The silicone is relatively thin so it is best to insert the tip as far as you can under the shake to avoid inadvertently dripping silicone on the surface of the Shakes that are below or adjacent to the shake being tabbed down. It would be prudent to have a damp rag available in case some minor cleanup is needed.

The 12 1/4 inch parts will require 2 dollops at each corner anywhere from 1 to 4 inches from the edge. If you choose to also tab down the 5 1/4" and 7 1/4" parts each require only 1 dollop in the center of the part.

As you can see, this silicone is extremely tacky and grabs onto the parts very easily. Once applied, simply press down on the part and the silicone will bond to both surfaces. ***If used in the amounts recommended, 3 tubes of silicone should cover 1 full square of shakes (5, 7 & 12 tab down).***



*Color Silicone was used in this example photo to show how it was used. **Clear silicone should be used in real world applications.**

The recommended silicone is GE **Clear Silicone II silicone adhesive/caulk

*** We do not recommend that the silicone is exposed to UV rays.

RESOURCES

CeDUR Product Resources: www.cedur.com/resources

Safety Data Sheet (SDS): www.cedur.com/resources

CeDUR Installation Videos on website: www.cedur.com/videos

CeDUR Installation Videos on YouTube: www.youtube.com/cedurshakes

ICC Report: www.cedur.com/resources **OR** Google Search “ICC ESR 3838”

Installation Instructions (English & Spanish): www.cedur.com/installation-recommendations

For roof specific installation questions please contact us at:

(720) 974-9200
info@cedur.com
www.cedur.com

(720) 974-9200
info@cedur.com
www.cedur.com